



NESTABLE BOX

Made from grey polypropylene, the Nestable Box series stacking containers have a truncated cone shape: when fully loaded they can be stacked firmly and safely, when they are empty they can be stacked one inside the other with a reduction of 70% of their volume. For this reason they are used to exploit warehouse space and for transport, especially as regards transport with empty return journeys and wherever packing must occupy as small a space as possible.

HAND GRIP

The flush handles offer a safe and easy grip even for gloved hands.



stacking with closed cover

nesting with open cover



stacking support with open cover

nesting with the support

front view



SUPPORTS

The support (pic. 1) is pushed to its stop (pic. 2) and is blocked by pressing downwards (pic. 3).



support block

RAW MATERIAL

CODING NESTABLE BOX

PP

51 01

grey
polypropylene

PP

51 XB

turquoise
polypropylene



59 00



white
PP - food compliant

walls and bottoms configuration		material	colour	
FAX	NB	6422	A	0 51 01
		height	depth	width

NESTABLE BOX

600x400 mm



ART.		Container dim. mm		min. purchase order	sales lots	pallet dim. mm	availability
FAX NB 6422 A O	51 O1	600 x 400 x 225 h	38	136 units (pallet)	136 units (pallet)	1200 x 800 x 2100 h	on stock
	51 XB			136 units (pallet)	136 units (pallet)		on stock
	59 00			200 units	5 units		on request
FAX NB 6422 C O	51 O1	600 x 400 x 240 h	38	104 units (pallet)	104 units (pallet)	1200 x 800 x 2050 h	on stock
	51 XB			104 units (pallet)	104 units (pallet)		on stock
	59 00			200 units	4 units		on request
FAX NB 6422 B O	51 O1	600 x 400 x 230 h	38	136 units (pallet)	136 units (pallet)	1200 x 800 x 2100 h	on stock
	51 XB			136 units (pallet)	136 units (pallet)		on stock
	59 00			200 units	5 units		on request
FAX NB 6432 A O	51 O1	600 x 400 x 325 h	58	80 units (pallet)	80 units (pallet)	1200 x 800 x 2000 h	on stock
	51 XB			80 units (pallet)	80 units (pallet)		on stock
	59 00			200 units	4 units		on request
FAX NB 6432 C O	51 O1	600 x 400 x 340 h	58	76 units (pallet)	76 units (pallet)	1200 x 800 x 2200 h	on stock
	51 XB			76 units (pallet)	76 units (pallet)		on stock
	59 00			201 units	3 units		on request
FAX NB 6432 B O	51 O1	600 x 400 x 330 h	58	80 units (pallet)	80 units (pallet)	1200 x 800 x 2000 h	on stock
	51 XB			80 units (pallet)	80 units (pallet)		on stock
	59 00			200 units	4 units		on request
FAX NB 6442 A O	51 O1	600 x 400 x 425 h	74	64 units (pallet)	64 units (pallet)	1200 x 800 x 2120 h	on stock
	51 XB			64 units (pallet)	64 units (pallet)		on stock
	59 00			201 units	3 units		on request
FAX NB 6442 C O	51 O1	600 x 400 x 440 h	74	56 units (pallet)	56 units (pallet)	1200 x 800 x 2100 h	on stock
	51 XB			56 units (pallet)	56 units (pallet)		on stock
	59 00			201 units	3 units		on request
FAX NB 6442 B O	51 O1	600 x 400 x 430 h	74	64 units (pallet)	64 units (pallet)	1200 x 800 x 2120 h	on stock
	51 XB			64 units (pallet)	64 units (pallet)		on stock
	59 00			201 units	3 units		on request

 Material/colour range

 PP

 PP

 PP

51 O1 grey polypropylene
51 XB turquoise polypropylene
59 00 white PP - food compliant

 OTHER COLOURS ON REQUEST

A



B



C



Volume in litres
per single unit



**CUSTOMISED
MARKING**
on request

LID



ART.		dim. mm	min. purchase order	sales lots	availability
	51 01		160 units (pallet)	160 units (pallet)	on stock
FAX NB 64SE 00	51 XB	610 x 400	160 units (pallet)	160 units (pallet)	on stock
	59 00		200 units	one unit	on request

TECHNICAL MEASURES

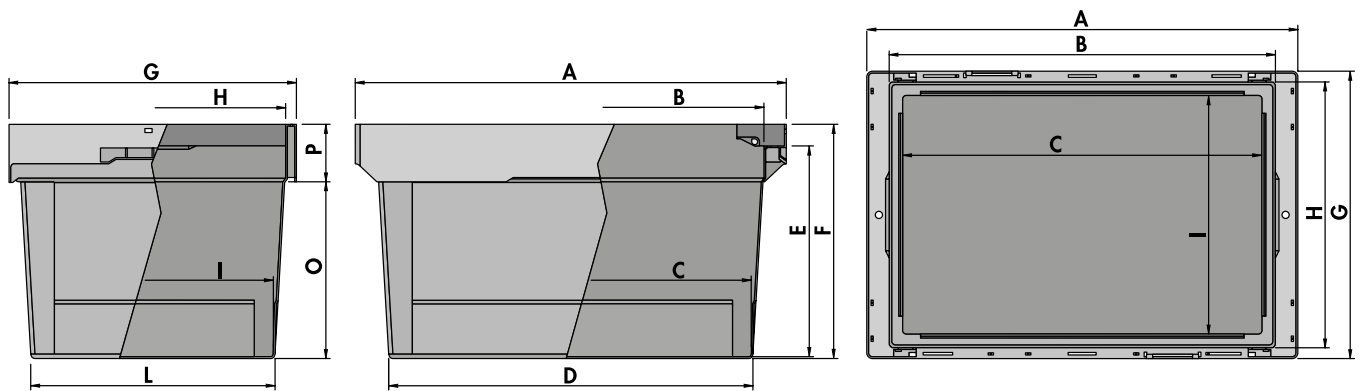

ART. CONTAINERS	A	B	C	D	E	F	G	H	I	L	O	P
FAX NB 6422 A 0	601	540	501	509	292	325	401	373	330	339	245	81
FAX NB 6432 A 0	601	524	455	535	178	201	398	368	338	345	141	60
FAX NB 6442 A 0	601	540	499	508	394	426	400	372	329	338	326	100
FAX NB 6422 B 0	601	532	501	508	192	229	400	370	330	339	174	50
FAX NB 6432 B 0	601	540	501	509	292	330	401	373	330	339	245	81
FAX NB 6442 B 0	601	540	499	508	394	431	400	372	329	338	326	100
FAX NB 6422 C 0	611	532	501	508	192	239	400	370	330	339	174	50
FAX NB 6432 C 0	611	540	501	509	292	340	401	373	330	339	245	81
FAX NB 6442 C 0	611	540	499	508	394	441	400	372	329	338	326	100



NESTABLE BOX LIGHT

Made from grey polypropylene, the Nestable Box Light series stacking containers have a truncated cone shape: when fully loaded they can be stacked firmly and safely, when they are empty they can be stacked one inside the other with a reduction of 70% of their volume. They are used to optimize warehouse space and in transportation where it is necessary to reduce the transport volumes of the containers when they are empty.

HAND GRIP

open hand grip



SIDE WALLS

solid side walls



perforated side walls



BOTTOM

solid bottom



perforated bottom

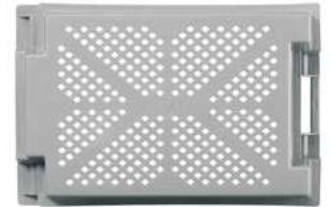

STACKING

front view



side view with cover

without lid



RAW MATERIAL



51 01

grey polypropylene



51 XB

turquoise polypropylene



59 00



white food compliant

CODING NESTABLE BOX LIGHT

walls and bottoms configuration				material		colour
FAX	NL	6420	B	0	51	01
		height	depth	width		
		series stacking container				

NESTABLE BOX LIGHT 600x400 mm



ART.		Container dim. mm		min. purchase order	sales lots	pallet dim. mm	availability
FAX NL 6420 B O	51 01	600 x 400 x 200 h	32	one unit	one unit	1200 x 800 x 2200 h	on stock
	51 XB			128 units (pallet)	128 units (pallet)		on stock
	59 00			128 units (pallet)	128 units (pallet)		on stock
FAX NL 6420 S O	51 01	600 x 400 x 200 h	32	128 units (pallet)	128 units (pallet)	1200 x 800 x 2200 h	on stock
	51 XB			128 units (pallet)	128 units (pallet)		on stock
	59 00			128 units (pallet)	128 units (pallet)		on stock
FAX NL 6430 B O	51 01	600 x 400 x 300 h	50	one unit	one unit	1200 x 800 x 2070 h	on stock
	51 XB			88 units (pallet)	88 units (pallet)		on stock
	59 00			88 units (pallet)	88 units (pallet)		on stock
FAX NL 6430 S O	51 01	600 x 400 x 300 h	50	88 units (pallet)	88 units (pallet)	1200 x 800 x 2070 h	on stock
	51 XB			88 units (pallet)	88 units (pallet)		on stock
	59 00			88 units (pallet)	88 units (pallet)		on stock
FAX NL 6440 B O	51 01	600 x 400 x 400 h	70	one unit	one unit	1200 x 800 x 2200 h	on stock
	51 XB			60 units (pallet)	60 units (pallet)		on stock
	59 00			60 units (pallet)	60 units (pallet)		on stock
FAX NL 6440 S O	51 01	600 x 400 x 400 h	70	60 units (pallet)	60 units (pallet)	1200 x 800 x 2000 h	on stock
	51 XB			60 units (pallet)	60 units (pallet)		on stock
	59 00			60 units (pallet)	60 units (pallet)		on stock

 Material/
colour range

 PP
51 01 grey
polypropylene

 PP
51 XB turquoise
polypropylene

 PP
59 00 white
PP - food compliant

 OTHER COLOURS
ON REQUEST

B



SOLID side walls



SOLID side walls
Open hand grip



SOLID bottom

S



PERFORATED
side walls



PERFORATED side walls
Open hand grip



PERFORATED
bottom



Volume in litres
per single unit



**CUSTOMISED
MARKING**
on request

ACCESSORIES



LID

ART.		dim. mm	min. purchase order	sales lots	availability
	51 01		one unit	one unit	on stock
FAX NL 64SE 00	51 XB	600 x 400	160 units (pallet)	160 units (pallet)	on stock
	59 00		160 units (pallet)	160 units (pallet)	on stock



PACKING SLIP FIXING SPRING

ART.	dim. mm	availability
FAXEBMB00000099	75 x 20 x 20	on stock



SNAP SPRING FOR LID CLOSING

ART.	dim. mm	availability
FAXNLMSC0000099	34 x 20 x 17	on stock

TECHNICAL MEASURES

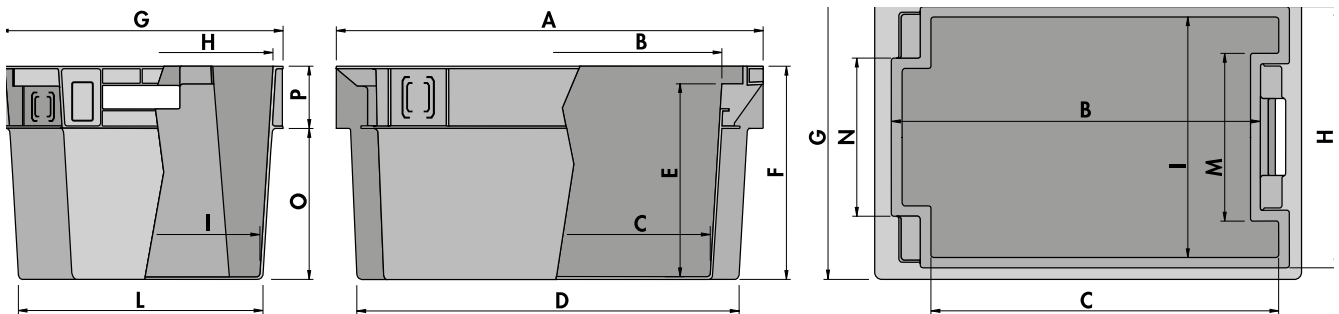

ART. CONTAINERS	A	B	C	D	E	F	G	H	I	L	M	N	O	P
FAX NL 6420 B 0	601	524	455	536	178	201	399	371	338	345	220	202	141	60
FAX NL 6420 S 0	601	524	455	535	178	201	398	368	338	345	219	202	141	60
FAX NL 6430 B 0	602	527	453	537	272	301	398	370	338	346	220	202	214	86
FAX NL 6430 S 0	601	525	455	536	273	300	398	370	336	345	220	202	214	86
FAX NL 6440 B 0	602	526	453	535	372	401	398	367	336	345	218	203	284	117
FAX NL 6440 S 0	601	526	454	535	374	401	399	370	337	344	220	202	285	117